

6-Channel Switch Control RF Receiver Module with Decoding

Learning Code, Superheterodyne, Switch Control, RF Receiver Module

SPECIFICATION

Model No.: DL-RX06C-LO6

Version: V1.3

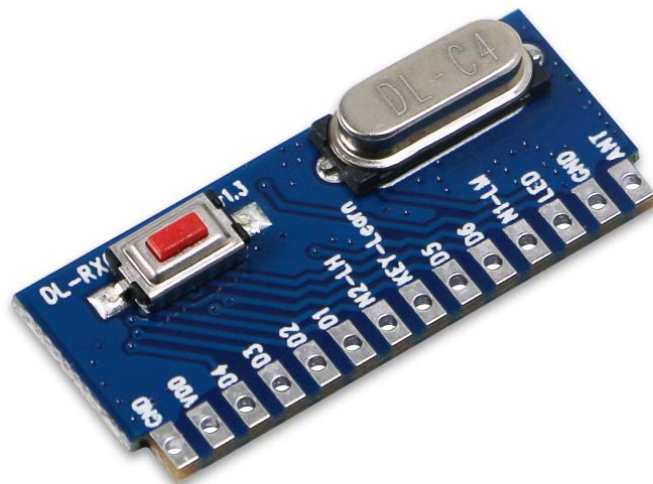

1. Module introduction

DL-RX06C-LO6 is a 6-Channel Switching Value RF Receiver Module with compact size. It is a high sensitivity super heterodyne ISM band wireless receive module, with decoding (learning code) function. It adopts cost-effective wireless data receiving chip and low power consumption MCU, with built-in image suppression function, can support 3V-5.5V wide voltage power supply, which performs high receiving sensitivity, as well as good anti-interference performance.

The module can meet your needs (realize the application) by setting the logic state of N1 and N2, and independently leads out 2 ports as following: Pairing status LED indicator, SW learning code-checking button. The LED indicator and SW learning code-checking button can be led to the circuit board or casing of the product, which is convenient for the user to operate.

DL-RX06C-LO6 leads out the N1 and N2 setting ends from the module, and the pins adopt a 2.0mm pitch to reduce the size of the module. It also adopts T-type board double-sided in-line pad design. Its bottom plate uses a slotted in-line method, which the module can be inserted directly on the circuit board and then wave soldering. By this way, it can save the soldering of the pin header and reduce the height of the module to 10mm.

DL-RX06C-LO6 are compatible with PT2262 and 1527 encoding. The corresponding decoding and receiving module can also be ODM (customized) according to different remote-control encoding types.

2. Antenna Description

Antenna pin of DL-RX06C-LO6 module is ANT, it can be added with single-ended simple antenna (straight wire) to improve the receiving sensitivity. Its control distance depends on the receiving antenna, receiving sensitivity, remote controller's transmit power, and transmit antenna.

Recommended single-core antenna length reference:

315M == 25 CM; 433M == 18 CM (based on actual test results)

Measured reference distance:

DL-RX06C-LO6 plus antenna (must be straightened), with our standard 6-button remote control, the test reference distance in open ground is about 300 meters.

We can optimize the performance of the on-board impedance matching network and remote controller; according to the structural space of the products (refer to the design diagram 3 for the placement of the antenna and the matching network):

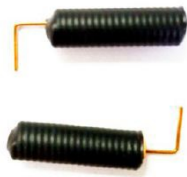

Figure 1: DL-ATH02R-433

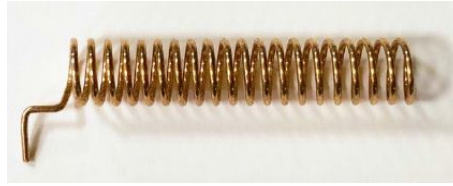

Figure 2: DL-ATH01-433

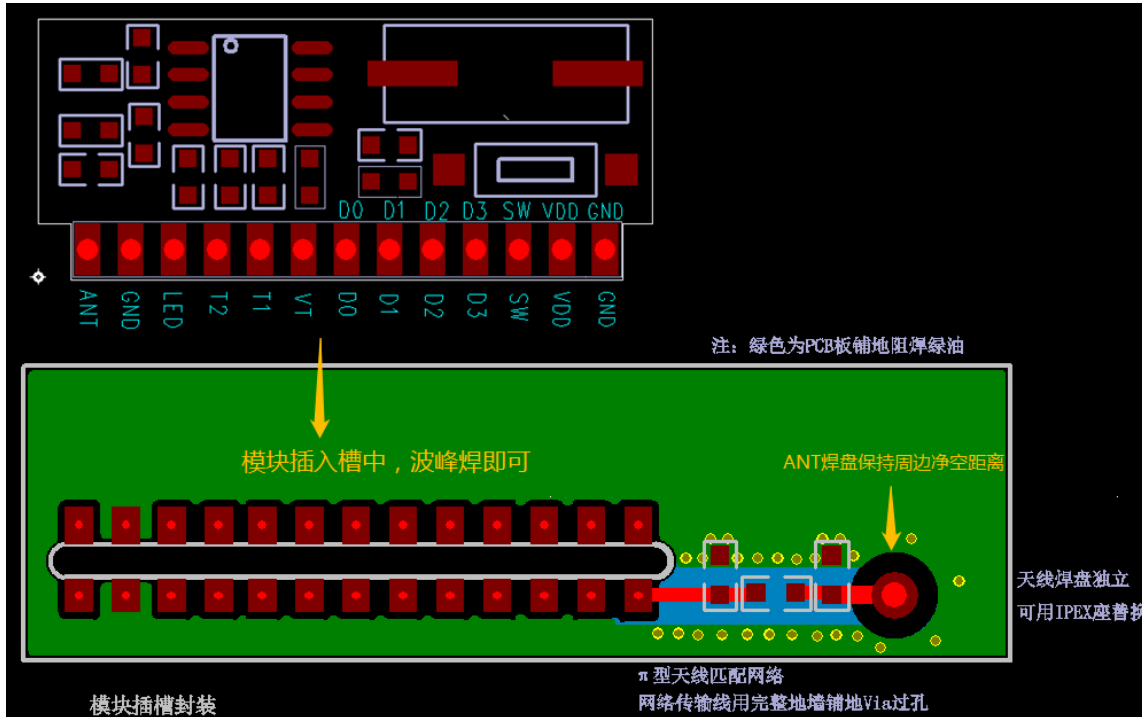

Figure 3: Schematic diagram of module insertion and antenna layout

Note: It is not recommended to weld the spring antenna directly to the ANT pin of the module. Coupling to the antenna feed point through a π -type network, when welding spring antennas (as Diagram 1 and 2) on the pads of the feed point, keep the height of the antenna from the floor as far as possible, and away from the high-frequency interference sources, so that the antenna maintains a certain clear space. To achieve the best antenna effect, please provide the complete product structure, housing, PCBA, etc. Our antenna engineer will match the best π -type impedance for you.

3. Applications

- Multi-channel controller for electric vehicles
- Multi-channel input and output switching control
- Remote control of multi-channel chandelier and lighting
- Wireless multi-channel opening and closing controller
- Standard 1527 protocol remote control
- Screen/curtain Lift Controller
- Multi-level control circuit
- D1-D6 can directly drive Darlington and relay circuits;
- Intelligent buildings
- Multi-channel on-off control of motors

4. Features & Brief Introduction:

- Frequency range: 315MHz, 433.92MHz (special frequency can be customized)
- Sensitivity: Up to -112 dBm
- Power supply voltage input range: 3V-5.5V (recommended working voltage is 5.0V)
- Latch and non-latching mode selection: Set N1/ N2 decoding, output latch / unlatching
- It can be used to learn PT2260, 2262, 1527 remote controllers with good rate compatibility
- Encoded data transmission rate 2.5K bps (Manchester encoding)
- OOK modulation mode, can work with PT4450, 115H, 113, R25 (2SK3356) and other transmitting circuits
- Module size 29 × 12.8 × 6mm (T type plate)

5. Technical Parameter

Parameter	Symbol	State	Reference Value			Unit
			Min.	Typ.	Max.	
Working frequency	Fc		315 , 433.92			MHz
Modulation Mode			ASK			
Receiving sensitivity		50 ohm antenna direct input /1k Kbps	-112			dBm
RF Receive bandwidth			300			KHz
Data demodulation bandwidth		Demodulation pulse width is 0.2-1ms	1	2.5		K
Low Power Average Current	I			300		uA
Supply Voltage	VDD		3.0	5.0	5.5	V
Working Current	IRC	VDD=3.3V/315M		4.5		mA
		VDD=3.3V/433M		6		mA

Logic Truth Table	N1: L (Latching) M (Inching)	N2: L (Low-level) H (High-level, Normal)	State description
Inching (M) mode 01	Low level (GND) 0	High level (NC) 1	D1-D6 output Inching mode (momentary control), Not low power consumption, with ordinary TX
L Self-locking mode 11	High level (NC) 1	High level (NC) 1	D1-D6 output Latch mode, Not low power consumption, with ordinary TX
L Self-locking mode 10	High level (NC) 1	Low level (GND) 0	D1-D6 output Latch mode, low power consumption, with delay TX
Inching (M) mode 00	Low level (GND) 0	Low level (GND) 0	D1-D6 output Inching mode (momentary control), low power consumption, with delay TX

Note: To confirm that the setting is valid, the red DK tool board needs to be powered on and reset, every time after setting the N1 and N2 states

6. Module size

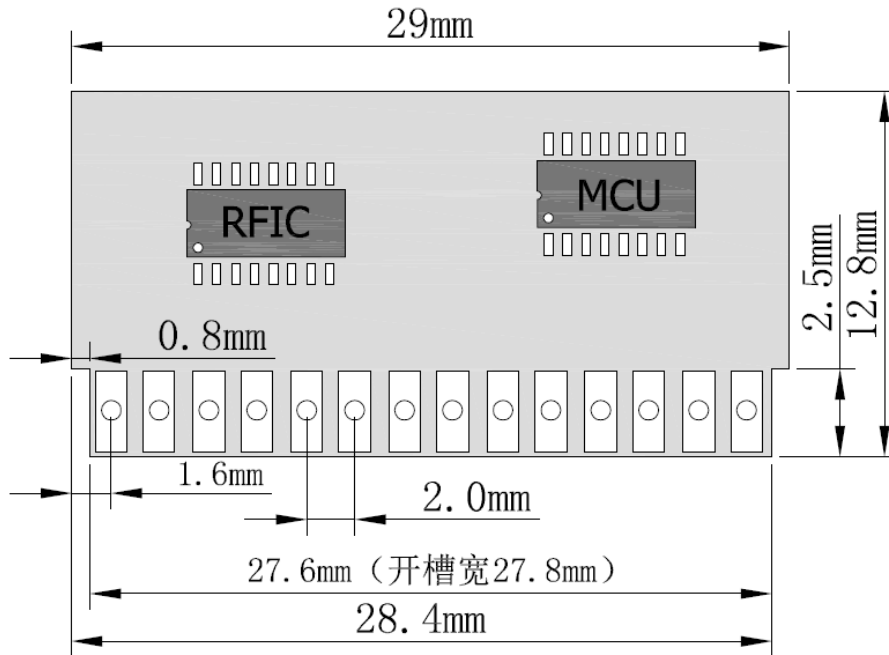

Figure 4: DL-RX06C-LO6 Dimensions

7. Pin Definitions

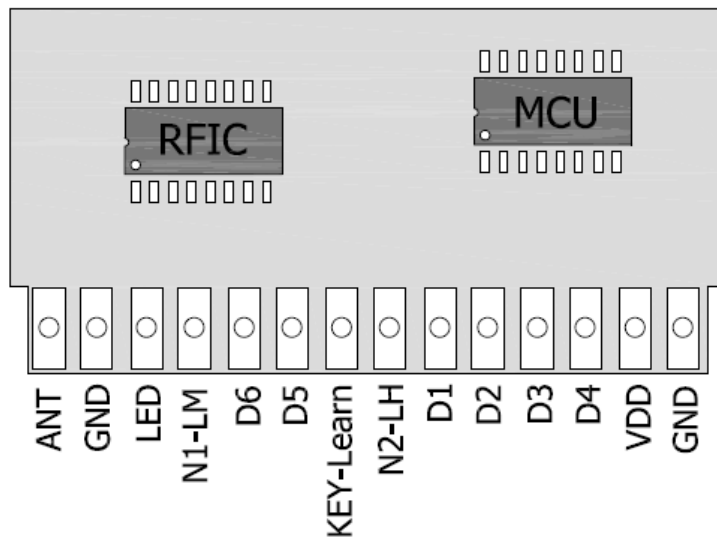

Figure 4 Module DL-RX06C-LO6 Pins Definition

Pin	Description
VDD	Power supply 3.0-5.5V, it is recommended to use LDO or battery output, Standard voltage 3.3V or 5.0V
GND	Grounding , reliably grounded and close to the system filter capacitor
LED	External pairing LED indicator, press 2S for pairing, light on and flashes 3 times quickly means matching succeed, 8S long press until light off to clear the code

KEY-Learn	Code learning key can be externally connected to the base plate and product shell. Long press 2s to enter pairing state, and 8s long press until light off to clear the code
N1、N2	Working mode setting pins, detailed setting refers to the Logic Truth Table. N1 set the signal output mode, N2 set the low power consumption and common receiving mode
D1-D6	D1-D4 for standard four-key remote control, and D1-D6 for standard six-key remote control respectively
ANT	Antenna (Refer to Figure 3 to design the patch cord and signal feed point)

Description: D1-D6 data output, corresponding to different remote-control key values, can output 0000-1111 BCD code (need to customize).

EV1527 million group learning code encoding IC chip pin correspondence table: K0-K3 key combination

K3	K2	K1	K0		D3	D2	D1	D0
0	0	0	1		0	0	0	1
0	0	1	0		0	0	1	0
0	0	1	1		0	0	1	1
0	1	0	0		0	1	0	0
0	1	0	1		0	1	0	1
0	1	1	0		0	1	1	0
0	1	1	1		0	1	1	1
1	0	0	0		1	0	0	0
1	0	0	1		1	0	0	1
1	0	1	0		1	0	1	0
1	0	1	1		1	0	1	1
1	1	0	0		1	1	0	0
1	1	0	1		1	1	0	1
1	1	1	0		1	1	1	0
1	1	1	1		1	1	1	1

8. Module Slot Size Description:

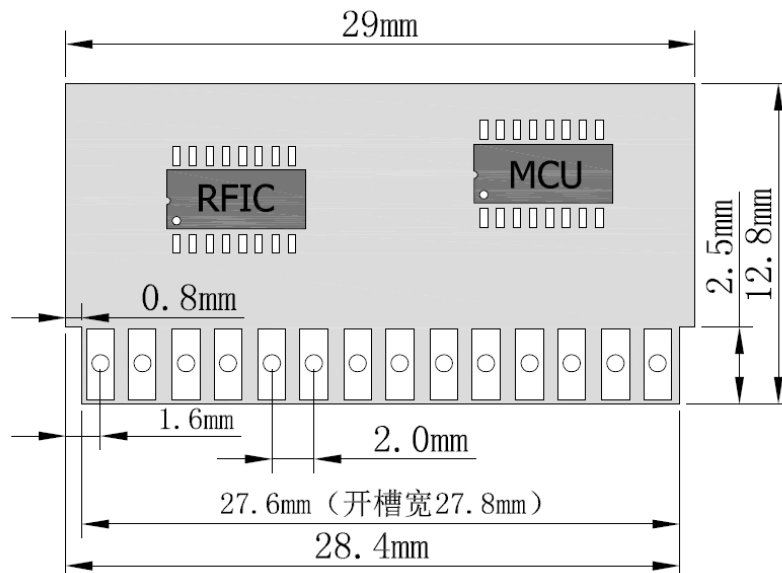

Description: The PINs adopt common 2.0mm hole design, compatible with 14PIN gold finger, and has a T-shaped plate with two steps design.

When applying a module, if there is no height limit, we can add a 2.0 mm higher pin header to the product soleplate (for welding); if there is a height limit, you can slot 27.8 mm in the soleplate, reserve 2.0 mm gap on both sides, and then insert the module directly into the soleplate for welding.

9. Remote control matching instructions

- DL-RX06C-LO6 can be used with 1527, 2260, 2262, 2264 coded remote control of the same frequency, and can learn to store 12 coded addresses. 2262 series coded remote control can set the address manually. The same address does not limit the number of matching devices. You only need to learn one remote control to use it.
- 1527 million coded remote controls, each with an address, can be paired with up to 12 remote controls, more than 12 can no longer be learned. If the remote control is losing, you can clear the coding by key and learn again.
- When DL-RX06C-LO6 is used with universal remote control on the market, the following points should be noticed:
 - 1) Carrier frequency needs to be the same;
 - 2) Transmission rate (period) needs to be the same; the minimum period of data can be captured with a logic analyzer or an oscilloscope, and the period can be as close as 1.6ms by fine tuning the resonant resistance;
 - 3) Different coded chip brands have different resonance resistance values;
 - 4) The corresponding voltage of different resonance resistances are also different, the resonance frequency is different when the power supply voltage of the same remote-control circuit is different (3.3V, 3.6V, 9V, 12V battery power), and the corresponding fine-tuning resistance is required.

10. Low power mode description

DL-RX06C-LO6 consists of antenna input matching circuit, radio frequency receiving chip, MCU and memory chip. It consumes 5.5mA of current when processing data in normal receiving mode. Receiving signals requires a long waiting period, and for many battery-powered products this current indicator affects the life of the battery. DL-RX06C-LO6 Receive Module provides a low power receive mode selection port. You can extend battery life by putting the Receive Module in a low power mode as needed.

Low-power mode uses a low-power MCU to wake up the receiving chip periodically, to scan if there is a carrier signal. Once the carrier signal is detected, it starts receiving and processing the encoded data, output high level; if no carrier signal, the receiving chip immediately goes to sleep, output 0 level. The sleep and wake-up of the receiving chip are controlled by the MCU program of the module. The duty cycle of the sleep and wake-up determines the average

receiving current of the receiving chip. Receiving module cannot receive signal when it enters sleep mode. It needs MCU to wake up receiving and processing data regularly. At this time, the encoding time of remote control needs to be extended to about 1s-2s, so as to avoid the remote control encoding instantly when receiving module is in sleep.

Once receive module enters low power mode, average standby current is only 0.2mA @ 315M, average standby current is 0.3mA @ 433M, which can prolong the battery's lifespan, but it requires the remote control launch time to be greater than 1-2 seconds (a cycle between "sleep" and "wake up"). Because when the remote-control key is pressed to transmit the encoded signal, the receiver may be sleeping and cannot receive the signal. It is necessary to wait for a while (the receiving chip to wake up by the MCU timer) to receive the encoded signal normally, the high level will be output only after address code and data code are determined. Received outputs in low power mode have a delay output of up to 2 seconds. If the receiving chip is in the receiving state at the time of transmission, the high level will be output immediately. Low power consumption is dynamically coupled with launch duration and can be customized according to the detailed applications. N1, N2 suspension can cause instability, it is recommended to connect VDD or GND.

11. Latch (Locking) / Inching (Momentary control) Mode

DL-RX06C-LO6 has the basic Latch/ Inching mode function of PT2272 encoding chip. This port can be selected according to different product functions. When N1 is connected to the VDD receiving module, the output level is locked (self-locking), press the remote-control key once, the corresponding receiving output port outputs high level and lock simultaneously; Press the key again and the corresponding receiving port will output 0 level.

Standard version of the module's lock mode is self-locking, if interlocking mode is required, you can contact us...

If N1 is connected to GND pin, receiving module's output level is in Inching (Momentary control) Mode, hold on the remote-control key, the corresponding receiving port will output high level, loosen the launch key, the corresponding receiving port will output 0 level. After the Latch / Inching mode conversion, the receiving module must power off once, and let the MCU program reset to convert. NC of N1 can cause instability, either by VDD or by GND.

12. Code matching

DL-RX06C-LO6 has a pairing key and pairing LED, the receive module needs to be powered on to match the code, press the receive pairing button (must be released), the LED is on, press any button to transmit, when the light flashes quickly and goes out, the code is successfully matched. Then you can use the 4 buttons (or 6 buttons) on the remote control to control the output of the output ports to output high levels, see the test circuit.

If the LED of the receiving module is off, the code cannot be matched. You need to check whether the receiving power is normal, the remote control is normal, whether it belongs to 2262, 1527 encoding; if you can match the code, but cannot remote control, you need to confirm

whether the code width is within the range, DL-RX06C-LO6 does not support other format encoding (except 2262, 1527 encoding).

13. Problems in module application

The communication distance is too close, and the ideal distance is not reached at all	
Interference source	Temperature, humidity, and co-channel interference will increase the communication packet loss rate (seawater absorbs radio waves, so the test effect
Antenna	There is a metal object near the antenna, or placed in a metal shell, the signal attenuation will be very serious, keep the antenna clear distance
Setting pins	N1 and N2 are output modes; they are setting pins of the module, which are commonly used in application. Please refer to the interface definition for correct
Parameter values	The module was default as 433.92MHz, 2.5Kbps rate, sensitivity is -112dBm; and the output signal state is determined by N1 level
Low voltage	The power supply voltage is lower than 3.3V, the lower the voltage, the lower the receiving sensitivity. When the voltage is lower than 3V, the RF chip does not receive data normally
The module is hot and easily damaged	
Power supply	Please check the power supply to ensure that it is between 3.0V ~ 5.5V, 5.0V is recommended
Stability	Please check the power supply stability, the voltage should not fluctuate significantly and frequently
Anti-static	Please ensure anti-static operation during installation and use, high-frequency devices have electrostatic sensitivity

14. Contact us

Shenzhen DreamLnk Technology Co., Ltd

★ Data collection, Smart home, Internet of Things applications, Wireless remote control technology, Remote active RFID, Antennas ★

Office Add.: Room 603, Unit C, Zone A, Huameiju Business Center, Xinhua Rd., Bao'an District, Shenzhen, Guangdong Province, China

Factory Add.: 5th Floor, Building B, Huazhi Innovation Valley, No. 7 Yuhua Street, 138 Industrial Zone, Tangxia Town, Dongguan, Guangdong Province, China

TEL.: +86-755-29369047

FAX: +86-755-27844601

Mobile: +86 13760215716

Wechat: wsj_james

E-mail: james@dreamlnk.com

Web: www.iot-rf.com